

AZIMUTHAL DISTRIBUTIONS IN RADIATIVE DECAY OF A POLARIZED τ LEPTON

G. I. Gakh^{a,b}, *M. I. Konchatnij*^{a*}, *N. P. Merenkov*^{a,b**}

^a NSC “Kharkov Institute of Physics and Technology”
61108, Kharkov, Ukraine

^b Karazin Kharkiv National University
61022, Kharkov, Ukraine

Received May 19, 2015

We investigate various distributions over emitted photon angles, especially over the azimuthal angle, in the one-meson radiative decay of the polarized τ lepton, $\tau^- \rightarrow \pi^- \gamma \nu_\tau$. In connection with this, the photon phase space is discussed in more detail because it is nontrivial in the case of a polarized τ lepton. The decay matrix element contains both the inner bremsstrahlung and the resonance (structural) contributions. The azimuthal dependence of some observables are calculated. They are the asymmetry of the differential decay width caused by the τ -lepton polarization, the Stokes parameters of the emitted photon itself, and the correlation parameters describing the influence of τ -lepton polarization on the photon Stokes parameters. A numerical estimation is done in the τ -lepton rest frame for an arbitrary direction of the τ -lepton polarization 3-vector. The vector and axial-vector form factors describing the structure-dependent part of the decay amplitude are determined using the chiral effective theory with resonances ($R\chi T$). It is found that the features of the azimuthal distributions allows separating various terms in the spin-dependent contribution. The so-called up–down and right–left asymmetries are also calculated.

DOI: 10.7868/S0044451016010089

1. INTRODUCTION

Recently, theoretical and experimental investigation of the various azimuthal asymmetries has acquired great interest. Experimentally, these asymmetries are measured in various processes. The distribution of the azimuthal angle for charged hadrons has been investigated in the deep-inelastic positron–proton scattering at HERA [1]. The azimuthal asymmetry and the transverse momentum of the forward-produced charged hadrons in muon deep-inelastic scattering on the deuterium target have been studied at Fermilab [2]. The azimuthal asymmetry was studied in the semi-inclusive deep-inelastic scattering of 160 GeV/c muons on a transversely polarized proton or deuteron target at CERN (the COMPASS experiment) [3]. The first measurement of the Drell–Yan angular distribution, performed by the NA10 Collaboration for pion–nucleon scattering, indicates a sizable azimuthal asymmetry

[4, 5]. The results of the measurement of the azimuthal asymmetry in the process $e^+e^- \rightarrow q\bar{q} \rightarrow \pi\pi X$ at the BaBar, where two pions are produced in opposite hemispheres, were presented in Ref. [6]. The results on the azimuthal asymmetry in the leptoproduction of photons on an unpolarized hydrogen target, measured at the HERMES experiment, were presented in Ref. [7]. We note that there are measurements not only of the azimuthal asymmetries but also of the asymmetries relative to the polar angle of a particle. The forward–backward asymmetries of the Drell–Yan lepton pairs (in the dielectron and dimuon channels) were measured in the proton–proton collisions at $\sqrt{s} = 7$ TeV [8], which were found to be consistent with the Standard Model predictions.

Theoretically, the azimuthal asymmetries in various hadron–hadron and lepton–hadron processes were investigated in a number of papers. The main goal of these studies is the elucidation of the momentum distribution of the partons in hadrons. Because it is a nonperturbative confining effect, it cannot be calculated *ab initio*. They are parameterized by introducing the longitudinal and transverse momentum (the so-

* E-mail: konchatnij@kipt.kharkov.ua

** E-mail: merenkov@kipt.kharkov.ua

called intrinsic transverse momentum) both in the parton distribution and in fragmentation functions. These distribution functions have received much attention recently [9]. The nonzero intrinsic transverse momentum of partons leads to various azimuthal asymmetries in the cross section when a hadron is produced in hard scattering processes. The asymmetry of pion production in the semi-inclusive deep inelastic scattering process of an unpolarized charged lepton on a transversely polarized nucleon target was calculated in Ref. [10]. The $\cos 2\phi$ azimuthal asymmetry of the unpolarized proton–antiproton Drell–Yan dilepton production process in the Z resonance region was considered in Ref. [11]. It was found that it is possible to study the spin structure of hadrons in unpolarized collision processes at the Tevatron. In Ref. [6], it was suggested to measure the Collins fragmentation function in the reaction $e^+e^- \rightarrow q\bar{q} \rightarrow h_1h_2X$, where two hadrons are detected in opposite jets. The measurement of the nuclear dependence of the azimuthal asymmetry in unpolarized semi-inclusive deep-inelastic scattering from various nuclei allows obtaining a valuable information about the energy loss parameter, which is one of a fundamental transport parameters of hadronic matter [12]. The authors of Ref. [13] considered the forward–backward pion charge asymmetry for the $e^+e^- \rightarrow \pi^+\pi^-\gamma$ process. The asymmetry is sensitive to the mechanisms involved in the final-state radiation and provides information on the pion form factor.

In the last decade, the interest in different decays of the τ lepton was stimulated by the plans to construct SuperKEKB (Japan) and Super $c\text{-}\tau$ (Russia) facilities [14–16]. The designed luminosity ($10^{35} \text{ cm}^{-2}\cdot\text{s}^{-1}$ for the Super $c\text{-}\tau$ and $10^{36} \text{ cm}^{-2}\cdot\text{s}^{-1}$ for the Super KEKB) will allow accumulating more than 10^{10} events with τ -lepton pairs. The very high statistics of the events gives a possibility to investigate the rare decays and search for the new physics beyond the Standard Model, such as the lepton flavor violation, CP violation in the leptonic sector, and so on. A review of the present status of τ physics can be found in Ref. [17].

As we see, the investigation of various angular distributions, especially the azimuthal asymmetries, can give additional valuable information about (or simplify the extraction of) the mechanisms of the relevant reactions. We apply this approach to study the angular distributions over the polar and azimuthal angles of the photon emitted in the polarized τ -lepton decay, $\tau^- \rightarrow \pi^-\gamma\nu_\tau$.

The reasons to study this decay and a short review of papers devoted to it can be found in Ref. [18], where we have investigated the radiative one-meson decay of

the τ lepton, $\tau^- \rightarrow \pi^-\gamma\nu_\tau$. The photon energy spectrum and the t -distribution (where t is the square of the invariant mass of the pion–photon system) of the decaying unpolarized τ lepton have been calculated and the polarization effects in this decay have also been studied. The following polarization observables have been calculated in the τ -lepton rest frame: the asymmetry caused by the τ -lepton polarization, the Stokes parameters of the emitted photon, and the spin correlation coefficients that describe the influence of the τ -lepton polarization on the photon Stokes parameters. All these quantities were calculated as functions of the photon energy or the t variable. No distributions over the polar and azimuthal angles of the emitted photon were considered.

In this paper, we study various angular distributions in the polarized τ -lepton decay $\tau^- \rightarrow \pi^-\gamma\nu_\tau$. In connection with this, the photon phase space is discussed in more detail since it is nontrivial in the case of a polarized τ -lepton. The azimuthal dependence of some observables are calculated. These are the asymmetry of the differential decay width caused by the τ -lepton polarization, the Stokes parameters of the emitted photon itself, and the correlation parameters describing the influence of τ -lepton polarization on the photon Stokes parameters. The numerical estimation is done in the τ -lepton rest frame for an arbitrary direction of the τ -lepton polarization 3-vector. The so-called up–down and right–left asymmetries are also calculated.

The paper is organized as follows. In Sec. 2, the matrix element of the decay $\tau^- \rightarrow \pi^-\gamma\nu_\tau$ is considered, and definitions of the basic quantities are given. Section 3 is devoted to the calculation of the integral right–left asymmetries as functions of the variable t . In Sec. 4.1, the photon angular phase space is analyzed in more detail. The calculation of the distributions over the photon azimuthal angle (in both the polarized and unpolarized case) is given in Sec. 4.2. The up–down differential asymmetries are calculated in Sec. 4.3. Section 4.4 contains the calculation of right–left differential asymmetries. Section 5 contains a discussion of the obtained results, and the conclusion is given in Sec. 6.

2. GENERAL FORMALISM

The main goal of our study is the investigation of various distributions over the angles of the emitted photon, especially over the azimuthal angle, in the radiative

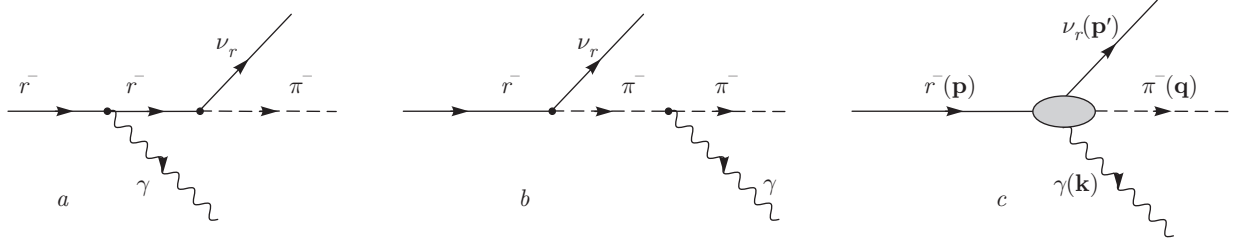

Fig. 1. Feynman diagrams for the radiative $\tau^- \rightarrow \pi^- + \nu_\tau + \gamma$ decay. Diagrams *a* and *b* correspond to the so-called structure-independent IB for which it is assumed that the pion is a point-like particle. Diagram *c* represents the contribution of the structure-dependent part and is parameterized in terms of the vector and axial-vector form factors

semileptonic decay of a polarized τ -lepton (the emitted photon can be also polarized)

$$\tau^-(p) \rightarrow \nu_\tau(p') + \pi^-(q) + \gamma(k). \quad (1)$$

The amplitude of this decay (Fig. 1) includes the inner bremsstrahlung (IB) contribution, caused by the radiation of the τ lepton and the point-like pion (diagrams *a* and *b*), and the structure-dependent (SD) contribution (diagram *c*). The SD part of the amplitude is usually described in terms of the vector and axial-vector form factors that depend on the invariant mass squared of the photon and pion, $t = (k + q)^2$. Different theoretical models have been suggested to calculate these form factors [18–24] and to derive the differential distributions over the energies and the invariant variable t in the τ -lepton rest frame in the case of unpolarized and polarized τ [18, 22].

The most developed models, based on the chiral effective theory with resonances (R χ T), were used in Refs. [18, 21, 24]. This theory is an extension of the chiral perturbation theory to the region of energies around 1 GeV, which explicitly includes the meson resonances, and has numerous applications to various aspects of the meson phenomenology [25–27].

We have the decay amplitude

$$M_\gamma = M_{IB} + M_R,$$

$$iM_{IB} = ZM\bar{u}(p')(1 + \gamma_5) \times \left[\frac{\hat{k}\gamma^\mu}{2(kp)} + \frac{Ne_1^\mu}{(kp)(kq)} \right] u(p)\varepsilon_\mu^*(k), \quad (2)$$

$$iM_R = \frac{Z}{M^2}\bar{u}(p')(1 + \gamma_5) \times \left\{ i\gamma_\alpha(\alpha\mu kq)v(t) - [\gamma^\mu(qk) - q^\mu\hat{k}]a(t) \right\} \times u(p)\varepsilon_\mu^*(k), \quad (3)$$

where $t = (k + q)^2$ and

$$(\alpha\mu kq) = \epsilon^{\alpha\mu\nu\rho}k_\nu q_\rho, \quad \epsilon^{0123} = +1,$$

$$\gamma_5 = i\gamma^0\gamma^1\gamma^2\gamma^3, \quad \text{Tr}\gamma_5\gamma^\mu\gamma^\nu\gamma^\rho\gamma^\lambda = -4i\epsilon^{\mu\nu\rho\lambda}.$$

We use the same notation as in our previous paper [18], namely, the dimensional factor Z incorporates all constants: $Z = eG_F V_{ud} F_\pi$, M is the τ -lepton mass, and $\varepsilon_\mu(k)$ is the photon polarization 4-vector. Here, $e^2/4\pi = \alpha = 1/137$, $G_F = 1.166 \cdot 10^{-5} \text{ GeV}^{-2}$ is the Fermi constant of the weak interactions, $V_{ud} = 0.9742$ is the corresponding element of the CKM matrix, and $F_\pi = 92.42 \text{ MeV}$ is the constant that determines the decay $\pi^- \rightarrow \mu^- \bar{\nu}_\mu$.

The vector $v(t)$ and axial $a(t)$ form factors in the M_R amplitude are given by

$$a(t) = -f_A(t) \frac{M^2}{\sqrt{2}mF_\pi}, \quad v(t) = -f_V(t) \frac{M^2}{\sqrt{2}mF_\pi},$$

where

$$f_A(t) = \frac{\sqrt{2}m_{\pi^\pm}}{F_\pi} \times \left[\frac{F_A^2}{m_a^2 - t - im_a\Gamma_a(t)} + \frac{F_V(2G_V - F_V)}{m_\rho^2} \right],$$

$$f_V(t) = \frac{\sqrt{2}m_{\pi^\pm}}{F_\pi} \times \left[\frac{N_C}{24\pi^2} + \frac{4\sqrt{2}h_V F_V}{3m_\rho} \frac{t}{m_\rho^2 - t - im_\rho\Gamma_\rho(t)} \right],$$

and $\Gamma_a(t)$ ($\Gamma_\rho(t)$) is the off-mass-shell decay width of the a_1 (ρ) meson. In our numerical calculations, we use two sets of the parameters entering these form factors, as indicated in Table.

We choose normalization such that the differential width of decay (1), in terms of the matrix element M_γ , has the form

$$d\Gamma = \frac{1}{4M(2\pi)^5} |M_\gamma|^2 d\Phi, \quad d\Phi = \frac{d^3k}{2\omega} \frac{d^3q}{2\epsilon} \delta(p'^2) \quad (4)$$

Table. Two sets of the coupling constants as given in [18]

| | F_A | F_V | G_V |
|-------|------------|-----------------|------------------|
| Set 1 | 0.1368 GeV | 0.1564 GeV | 0.06514 GeV |
| Set 2 | F_π | $\sqrt{2}F_\pi$ | $F_\pi/\sqrt{2}$ |

in the τ -lepton rest system, where ω and ϵ are the energies of the photon and π meson and the factor that corresponds to averaging over the τ -lepton spin is included in $|M_\gamma|^2$. In writing $|M_\gamma|^2$, we have to use the relations

$$u(p)\bar{u}(p) = \hat{p} + M, \quad u(p)\bar{u}(p) = (\hat{p} + M)(1 + \gamma_5 \hat{S})$$

for unpolarized and polarized τ -lepton decays. Here, S is the τ -lepton polarization 4-vector.

The matrix element squared in the most general case is given by

$$|M_\tau|^2 = \Sigma + \Sigma_i,$$

where

$$\Sigma = T^{\mu\nu}(e_{1\mu}e_{1\nu} + e_{2\mu}e_{2\nu}), \quad \Sigma_1 = T^{\mu\nu}(e_{1\mu}e_{2\nu} + e_{1\nu}e_{2\mu}),$$

$$\Sigma_2 = -iT^{\mu\nu}(e_{1\mu}e_{2\nu} - e_{1\nu}e_{2\mu}),$$

$$\Sigma_3 = T^{\mu\nu}(e_{1\mu}e_{1\nu} - e_{2\mu}e_{2\nu}).$$

The quantity Σ defines the decay width in the case of an unpolarized photon, and the Σ_i characterizes the polarization states of the photon and can be used to define the Stokes parameters of the photon itself relative to the chosen polarization 4-vectors e_1^μ and e_2^μ . In what follows, we use

$$e_1^\mu = \frac{1}{N} [(pk)q^\mu - (qk)p^\mu], \quad e_2^\mu = \frac{(\mu p q k)}{N},$$

$$N^2 = 2(qp)(pk)(qk) - M^2(qk)^2 - m^2(pk)^2,$$

where m is the pion mass.

For a polarized τ -lepton, the current tensor is given by

$$T_{\mu\nu} = T_{\mu\nu}^0 + T_{\mu\nu}^S,$$

where the tensor $T_{\mu\nu}^S$ depends on the τ -lepton polarization 4-vector and the tensor $T_{\mu\nu}^0$ is independent of it. (For the definition and analytic form of $T_{\mu\nu}$, see Ref. [18].) In this case, we can write

$$\Sigma = \Sigma^0 + \Sigma^S, \quad \Sigma_i = \Sigma_i^0 + \Sigma_i^S,$$

and define the physical quantities

$$A^S = \frac{\Sigma^S d\Phi}{\Sigma^0 d\Phi}, \quad \xi_i = \frac{\Sigma_i^0 d\Phi}{\Sigma^0 d\Phi}, \quad \xi_i^S = \frac{\Sigma_i^S d\Phi}{\Sigma^0 d\Phi}, \quad (5)$$

which completely describe the polarization effects in the decay considered.

The quantity A^S is the polarization asymmetry of the differential decay width caused by the τ -lepton polarization. The quantities ξ_i define the Stokes parameters of the photon itself if the τ -lepton is unpolarized, and the ξ_i^S are correlation parameters describing the influence of the τ -lepton polarization on the photon Stokes parameters.

Hence, to analyze the polarization phenomena in process (1), we have to study both spin-independent and spin-dependent parts of the differential width. In accordance with Eq. (4), they are

$$\frac{d\Gamma_0}{d\Phi} = g\Sigma^0, \quad \frac{d\Gamma_0^S}{d\Phi} = g\Sigma^S, \quad \frac{d\Gamma_i}{d\Phi} = g\Sigma_i^0,$$

$$\frac{d\Gamma_i^S}{d\Phi} = g\Sigma_i^S, \quad g = \frac{1}{4M(2\pi)^5}.$$

The angular dependence in the distribution of the photon and pion in the rest frame arises due to the polarization of the τ lepton through the terms (Sk) , (Sq) and $(Spqk) = \epsilon_{\mu\nu\lambda\rho} S^\mu p^\nu q^\lambda k^\rho$ in the squared matrix element. The definition of the angles used is given in Fig. 2.

3. INTEGRAL RIGHT-LEFT ASYMMETRIES

The angular part of the phase space $d\Phi$ in Eq. (4) can be written as

$$d\Phi_a = \delta(c_{12} - c_1 c_2 - s_1 s_2 c_\phi) dc_1 d\phi_1 dc_2 d\phi_2,$$

where c_{12} is fixed by the energies of the photon and pion (we use the notation c_i and s_i for $\cos \theta_i$ and $\sin \theta_i$).

In the case of an unpolarized τ lepton, $|M_\gamma|^2$ is independent of any angles, and we can perform the full angular integration. The easiest way to do it is in the system with the z axis along the direction \mathbf{k} and the xz plane as the (\mathbf{k}, \mathbf{q}) one, with the result

$$d\Phi_a = 8\pi^2.$$

Of course, this result is independent of the choice of the coordinate system. With an arbitrary choice of the z axis, we can carry out one azimuthal integration and

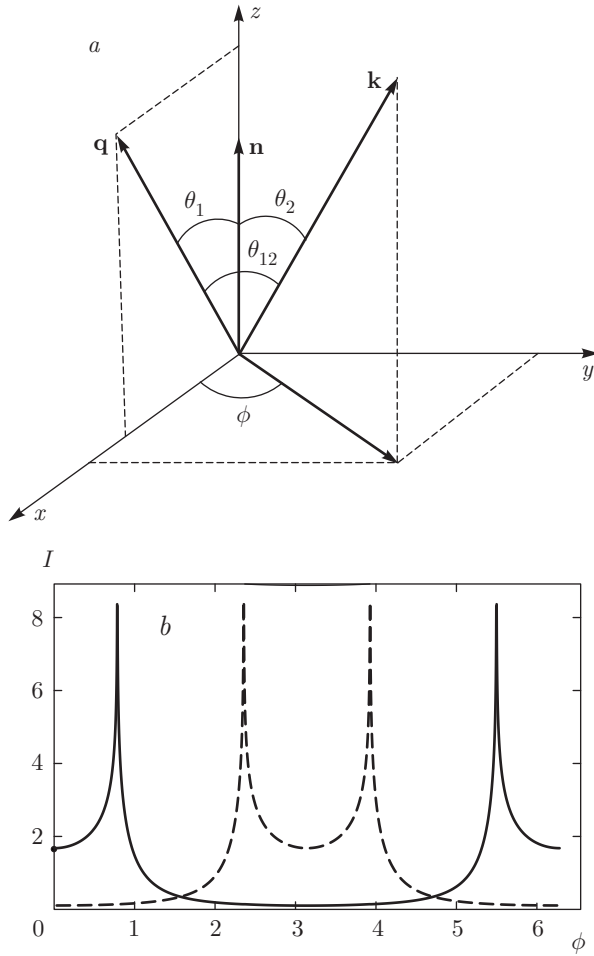

Fig. 2. Definition of the angles for a polarized radiative τ decay in the rest frame of the τ lepton; in this system, $S = (0, \mathbf{n})$ (a). The curves (b) are the functions $I(\phi, 0.707)$ (solid line) and $I(\phi, -0.707)$ (dashed line) given by Eqs. (31) and (32)

use the δ function, for example, to eliminate the second azimuthal angle. Then we obtain the well-known expression

$$d\Phi_a = 2\pi \frac{2dc_1 dc_2}{K(c_1, c_2, c_{12})}, \quad (6)$$

$$K(c_1, c_2, c_{12}) = \sqrt{(c_1 - c_{1-})(c_{1+} - c_1)},$$

$$c_{1\pm} = c_2 c_{12} \pm s_2 s_{12}.$$

The factor 2π in this relation reflects the arbitrariness in choosing the xz plane, and the factor 2 in the numerator takes the contributions of the right ($0 < \phi < \pi$) and left ($\pi < \phi < 2\pi$) hemispheres into account. The function $K(c_1, c_2, c_{12})$ is symmetric under the change of indices $1 \leftrightarrow 2$.

The double angular distribution, in this coordinate system, is nontrivial due to the dependence of

$K(c_1, c_2, c_{12})$ on c_{12} even in the case of an unpolarized τ lepton. But the single angular integration

$$\int \frac{dc_1}{K} = \int \frac{dc_2}{K} = \pi$$

eliminates this dependence and leads to the full factorization of the residual angular part.

We can use such an approach to describe the events corresponding to the polarized τ -lepton decay by choosing the coordinate system as shown in Fig. 2. In this case, the general form of the spin-dependent quantities Σ^S and Σ_i^S in relations (5) is very similar:

$$\Sigma^S = c_1 F_1 + c_2 F_2 + s_1 s_2 s_\phi F_3, \quad (7)$$

$$\Sigma_i^S = c_1 G_{i1} + c_2 G_{i2} + s_1 s_2 s_\phi G_{i3},$$

where $s_\phi = \sin \phi$ and the functions F_k and G_{ik} are independent of the angles. They depend on the pair dynamical variables that define unpolarized τ decay (the energies of the photon and pion). The functions F_1 (G_{i1}), F_2 (G_{i2}), and F_3 (G_{i3}) are respectively caused by the (Sq) , (Sk) , and $(Spqk)$ terms. They can be obtained using the results in Ref. [18].

If, as it was done above, we use the angular δ -function to perform the full azimuthal integration, the terms proportional to s_ϕ in (7) disappear. Further integrating over the pion polar angle

$$\int \frac{dc_1}{K} = \pi, \quad \int \frac{c_1 dc_1}{K} = \pi c_2 c_{12}, \quad (8)$$

leads to a very simple angular dependence:

$$\int \Sigma^S \frac{dc_1}{K} = \pi c_2 (c_{12} F_1 + F_2), \quad (9)$$

$$\int \Sigma_i^S \frac{dc_1}{K} = \pi c_2 (c_{12} G_{i1} + G_{i2}).$$

Formulas (9) show that the difference of events with a photon in the upper ($1 > c_2 > 0$) and lower ($0 > c_2 > -1$) hemispheres allows segregating the contribution of the spin-dependent terms (proportional to (Sq) and (Sk)) to the decay differential width. In accordance with the terminology used in this paper, we can call them the “integral up-down asymmetries”. These effects were considered in Ref. [18].

The information contained in the up-down asymmetry can also be obtained by changing the direction of the τ -lepton polarization vector ($\mathbf{n} \rightarrow -\mathbf{n}$), because under this change, we have $c_2 \rightarrow -c_2$ (since $\theta_2 \rightarrow \pi - \theta_2$). Sometimes, it is preferable to detect the photons in some region of θ_2 , as discussed above, rather than changing the direction of the τ -lepton polarization vector.

We suppose that we performed the azimuthal integration separately in the right and left hemispheres, in such a way that

$$d\Phi_a = d\Phi_{a+}(s_\phi > 0) + d\Phi_{a-}(s_\phi < 0) = 2\pi \left[\left(\frac{dc_1 dc_2}{K} \right)_R + \left(\frac{dc_1 dc_2}{K} \right)_L \right]. \quad (10)$$

The difference of the events in the right and left hemispheres is described only by the third terms in relation (7), and further integrating this difference with respect to c_1 and c_2 over the region

$$c_{1-} < c_1 < c_{1+}, \quad -1 < c_2 < 1$$

gives

$$\int \Sigma^S(d\Phi_{a+} - d\Phi_{a-}) = 4\pi^2 s_{12} F_3, \quad (11)$$

$$\int \Sigma_i^S(d\Phi_{a+} - d\Phi_{a-}) = 4\pi^2 s_{12} G_{i3}.$$

Thus, the corresponding measurements allow separating the contributions caused by the term ($Spqk$) in the decay width. The respective effects are called “integral right–left asymmetries”.

It is clear that we can carry out the integration in the right hand side of Eqs. (11) with respect to one of the dynamical variables ω, ϵ , or the invariant variable t . In the last case, the integration is performed analytically, and we can write an analytic expressions for all partial widths that contribute to the polarization asymmetry, the Stokes parameters, and the correlation parameters in terms of the vector and axial-vector form factors. The result is

$$\frac{d\Gamma_0^{RL}}{dt} = \frac{P}{2} \times$$

$$\times [\text{Im}(a(t))C_0^{RL}(t) + \text{Im}(v(t))D_0^{RL}(t)],$$

$$P = \frac{Z^2}{2^8 \pi^3 M^2}, \quad (12)$$

$$C_0^{RL}(t) = \frac{8}{M(t-m^2)} \times$$

$$\times [(t^2 + 2m^2M^2 + m^4)J_1 - 2M(t+m^2)J_2],$$

$$D_0^{RL}(t) = \frac{8}{M} [(t+m^2)J_1 - 2M J_2],$$

$$\frac{d\Gamma_1^{RL}}{dt} = \frac{P}{2} [I_1^{RL}(t) + (|a(t)|^2 - |v(t)|^2) A_1^{RL}(t) + \text{Re}(a(t))C_1^{RL}(t) + \text{Re}(v(t))D_1^{RL}(t)],$$

$$I_1^{RL}(t) = \frac{16 M^3}{t-m^2} [-J_1 + (t-m^2)J_3],$$

$$A_1^{RL}(t) = -\frac{4(t-m^2)}{M^3} [(t+M^2)J_1 - 2M J_2], \quad (13)$$

$$C_1^{RL}(t) = -16(M J_1 - J_2),$$

$$D_1^{RL}(t) = \frac{16}{M(t-m^2)} \times$$

$$\times [m^2(M^2 + t)J_1 - M(t+m^2)J_2],$$

$$\frac{d\Gamma_2^{RL}}{dt} = \frac{P}{2} \times$$

$$\times [\text{Im}(a(t))C_2^{RL}(t) + \text{Im}(v(t))D_2^{RL}(t)], \quad (14)$$

$$C_2^{RL}(t) = -D_0^{RL}(t), \quad D_2^{RL}(t) = -C_0^{RL}(t),$$

$$\frac{d\Gamma_3^{RL}}{dt} = \frac{P}{2} [\text{Im}(a^*(t)v(t))B_3^{RL}(t) + \text{Im}(a(t))C_3^{RL}(t) + \text{Im}(v(t))D_3^{RL}(t)], \quad (15)$$

$$B_3^{RL}(t) = 2A_1^{RL}(t), \quad C_3^{RL}(t) = D_1^{RL}(t),$$

$$D_3^{RL}(t) = C_1^{RL}(t).$$

The quantities $J_i, i = 1, 2, 3$, depend on the variable t and are defined as

$$J_1 = \int_{\omega_{min}}^{\omega_{max}} |\mathbf{q}| s_{12} d\omega,$$

$$J_2 = \int_{\omega_{min}}^{\omega_{max}} \left(\frac{M^2 + t}{2M} - \omega \right) |\mathbf{q}| s_{12} d\omega, \quad (16)$$

$$J_3 = \frac{1}{2M} \int_{\omega_{min}}^{\omega_{max}} \frac{|\mathbf{q}|}{\omega} s_{12} d\omega,$$

where $\omega_{min} = (t-m^2)/2M$ and $\omega_{max} = M(t-m^2)/2t$. The range of t is $m^2 \leq t \leq M^2$.

The analytic form of these integrals is very simple:

$$J_1 = \frac{\pi(M^2 - t)^2(t - m^2)}{4M\sqrt{t}(M + \sqrt{t})^2},$$

$$J_2 = \frac{M^2 + t}{2M} J_1 - \frac{\pi(M^2 - t)^2(t - m^2)^2}{32M^2t\sqrt{t}},$$

$$J_3 = \frac{\pi(M^2 - t)^2}{4M^2(M + \sqrt{t})^2}.$$

In Fig. 3, we show the t -dependences of some quantities that illustrate the right–left asymmetries integrated over the azimuthal angle. Together with the

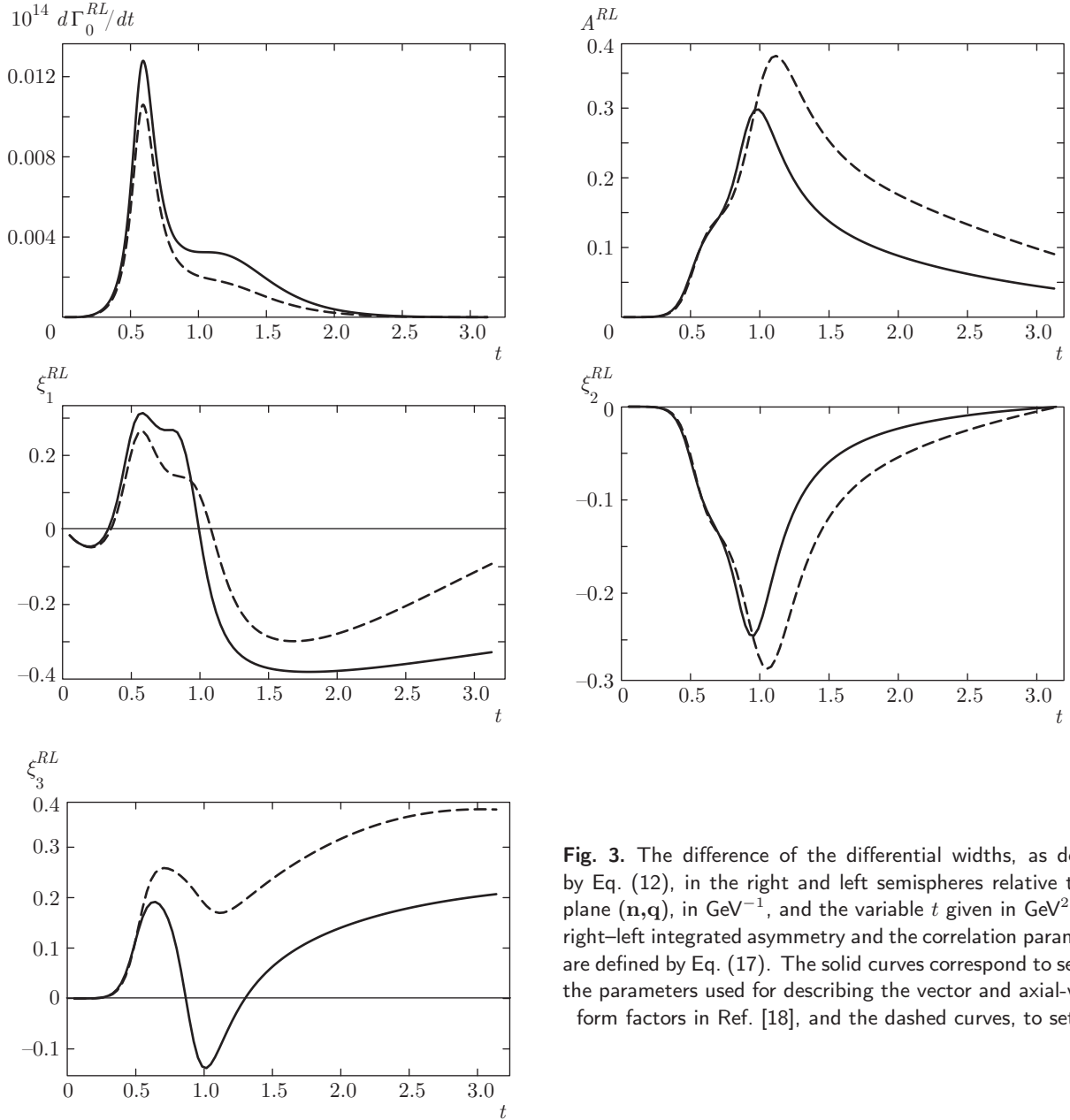

Fig. 3. The difference of the differential widths, as defined by Eq. (12), in the right and left semispheres relative to the plane (\mathbf{n}, \mathbf{q}) , in GeV^{-1} , and the variable t given in GeV^2 . The right–left integrated asymmetry and the correlation parameters are defined by Eq. (17). The solid curves correspond to set 1 of the parameters used for describing the vector and axial-vector form factors in Ref. [18], and the dashed curves, to set 2

decay width defined by Eq. (12), we present the right–left asymmetry $A^{RL}(t)$ and the correlation parameters $\xi_i^{RL}(t)$ defined as

$$A^{RL}(t) = \frac{d\Gamma_0^{RL}}{dt} / \frac{d\Gamma_0}{dt}, \quad \xi_i^{RL}(t) = \frac{d\Gamma_i^{RL}}{dt} / \frac{d\Gamma_0}{dt}, \quad (17)$$

where the expression for the unpolarized differential decay width $d\Gamma_0/dt$ is defined by Eq. (55) in Ref. [18]. We recall that the right–left asymmetries vanish for an unpolarized τ lepton.

4. DIFFERENTIAL AZIMUTHAL UP–DOWN AND RIGHT–LEFT ASYMMETRIES

4.1. Angular phase space of the photon

The main goal of this paper is to analyze the differential distributions over the azimuthal angle ϕ including the up–down and right–left asymmetries caused by the τ -lepton polarization. In this case, we have to use the δ -function in the angular phase space $d\Phi_a$ to do the integration with respect to θ_1 (or θ_2). This procedure leads to a more complicated angular part of the

phase space,

$$\frac{d\Phi_a}{2\pi} = dc_2 d\phi \left[\frac{\delta(c_1 - c_+) dc_1}{|c_2 - c_+ s_2 \cos \phi / s_+|} + \frac{\delta(c_1 - c_-) dc_1}{|c_2 - c_- s_2 \cos \phi / s_-|} \right], \quad (18)$$

where c_{\pm} are the solutions of the equation $c_{12} = c_1 c_2 + s_1 s_2 \cos \phi$ at fixed values of c_{12} , which are determined by any pair of the variables (ϵ, ω) , (ϵ, t) , or (ω, t) :

$$c_{\pm} = \frac{1}{c_2^2 + s_2^2 \cos^2 \phi} (c_2 c_{12} \pm s_2 \cos \phi Y),$$

$$Y = \sqrt{(c_2^2 + s_2^2 \cos^2 \phi - c_{12}^2)}.$$

For the calculations in what follows, we also need the quantities

$$s_{\pm} = \frac{1}{c_2^2 + s_2^2 \cos^2 \phi} |c_2 Y \mp s_2 c_{12} \cos \phi|.$$

The angular integration region, in this case, is more complex and is specified by the conditions

$$\begin{aligned} c_2^2 + s_2^2 \cos^2 \phi - c_{12}^2 &> 0, \\ (c_{12} - c_{\pm} c_2 > 0, \cos \phi > 0), & \quad (19) \\ (c_{12} - c_{\pm} c_2 < 0, \cos \phi < 0). & \end{aligned}$$

The entire integration region is divided into four parts depending on the choice of $c_1 = c_+$ or $c_1 = c_-$ and the values of $c_{12} > 0$ or $c_{12} < 0$.

The boundaries in the case $c_{12} > 0$ can be written as

$$\begin{aligned} [0 < \phi < \theta_{12}, \quad 2\pi - \theta_{12} < \phi < 2\pi, \\ -1 < c_2 < c_{12}, \quad \text{if } c_1 = c_+, \\ -c_{12} < c_2 < 1, \quad \text{if } c_1 = c_-], \\ [\theta_{12} < \phi < \pi/2, \\ 3\pi/2 < \phi < 2\pi - \theta_{12}, \\ -1 < c_2 < -X, \quad X < c_2 < c_{12}, \\ \text{if } c_1 = c_+, \\ -c_{12} < c_2 < -X, \quad X < c_2 < 1, \\ \text{if } c_1 = c_-], \quad X = \sqrt{1 - \frac{s_{12}^2}{\sin^2 \phi}}, \\ [\pi/2 < \phi < 3\pi/2, \quad -1 < c_2 < -c_{12}, \\ \text{if } c_1 = c_+, \quad c_{12} < c_2 < 1, \\ \text{if } c_1 = c_-]. \end{aligned} \quad (20)$$

For $c_{12} < 0$, we have

$$\begin{aligned} [0 < \phi < \pi/2, \quad 3\pi/2 < \phi < 2\pi, \quad -1 < c_2 < c_{12}, \\ \text{if } c_1 = c_+, \quad c_{12} < c_2 < 1, \quad \text{if } c_1 = c_-], \\ [\pi/2 < \phi < \theta_{12}, \quad 2\pi - \theta_{12} < \phi < 3\pi/2, \\ -1 < c_2 < -X, \quad X < c_2 < c_{12}, \quad \text{if } c_1 = c_+, \\ c_{12} < c_2 < -X, \quad X < c_2 < 1 \quad \text{if } c_1 = c_-], \\ [\theta_{12} < \phi < 2\pi - \theta_{12}, \quad -1 < c_2 < c_{12}, \\ \text{if } c_1 = c_+, \quad -c_{12} < c_2 < 1, \quad \text{if } c_1 = c_-]. \end{aligned} \quad (21)$$

The corresponding plots for the angular phase space in terms of the angles ϕ and θ_2 are shown in Fig. 4.

We can verify that for the ranges of the angular variables defined by inequalities (20) and (21) in both cases $c_{12} > 0$ and $c_{12} < 0$, the following relations always hold:

$$|c_2 Y - s_2 c_{12} \cos \phi| = s_2 c_{12} \cos \phi - c_2 Y,$$

for $c_1 = c_+$ and $s_1 = s_+$, and

$$|c_2 Y + s_2 c_{12} \cos \phi| = s_2 c_{12} \cos \phi + c_2 Y,$$

for $c_1 = c_-$ and $s_1 = s_-$. Therefore, we can rewrite the angular phase space in the form

$$\begin{aligned} \delta(c_{12} - c_1 c_2 - s_1 s_2 \cos \phi) dc_2 dc_1 d\phi &= \\ &= \bar{\Phi}_a dc_2 d\phi, \\ \bar{\Phi}_a = dc_1 \left[\frac{\delta(c_1 - c_+) (s_2 c_{12} \cos \phi - c_2 Y)}{Y(c_2^2 + s_2^2 \cos^2 \phi)} + \right. & \quad (22) \\ \left. + \frac{\delta(c_1 - c_-) (s_2 c_{12} \cos \phi + c_2 Y)}{Y(c_2^2 + s_2^2 \cos^2 \phi)} \right]. \end{aligned}$$

To be sure, we have to verify that the integration over the entire angular phase space, at arbitrary values of the c_{12} , results in 4π . We first note that if $c_{12} = 0$, then such integration reduces to

$$\begin{aligned} \int \bar{\Phi}_a(c_{12} = 0) dc_2 d\phi &= 2 \int_0^{2\pi} d\phi \int_0^1 \frac{c_2 dc_2}{c_2^2 + s_2^2 \cos^2 \phi} = \\ &= -4 \int_0^{\pi/2} \frac{\ln(\cos^2 \phi)}{\sin^2 \phi} d\phi = 4\pi. \end{aligned}$$

We investigate the case $c_{12} < 0$, for example. After simple algebraic manipulations, we can write

$$\begin{aligned} \int \bar{\Phi}_a dc_2 d\phi &= 2 \int_{-c_{12}}^1 \left\{ \int_0^{2\pi} \frac{c_2 d\phi}{c_2^2 + s_2^2 \cos^2 \phi} \right\} dc_2 + \\ &+ 2 \int_{c_{12}}^{-c_{12}} \left\{ \int_{\pi-y}^{\pi+y} \frac{s_2 c_{12} \cos \phi d\phi}{Y(c_2^2 + s_2^2 \cos^2 \phi)} \right\} dc_2, \quad (23) \\ y &= \text{Arcsin} \frac{s_{12}}{s_2}. \end{aligned}$$

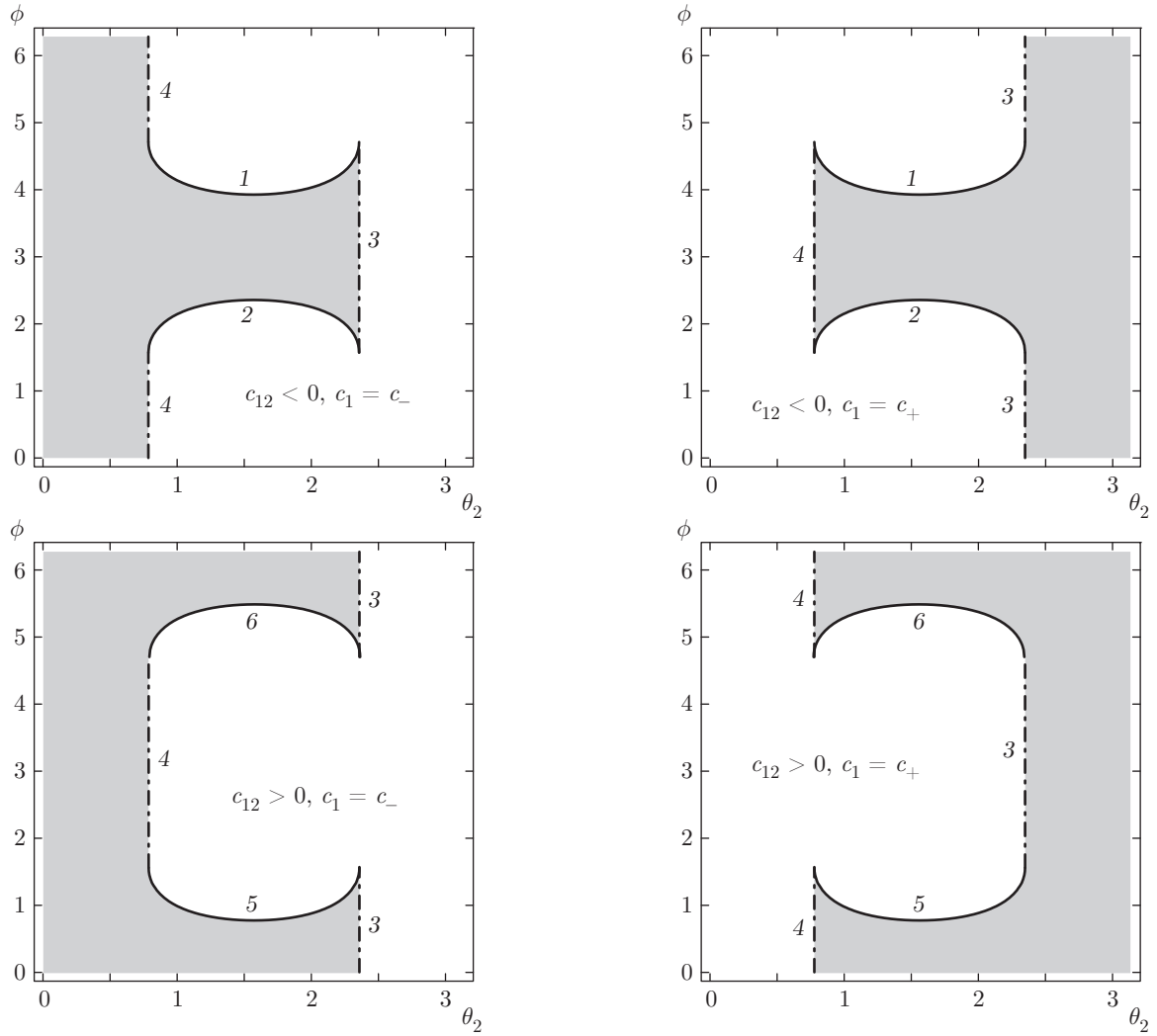

Fig. 4. Four parts of the angular phase space are given in terms of the azimuthal ϕ and polar θ_2 angles of the photon. Only the crosshatched regions are permitted. On lines 4 and 3, $c_2 = \pm|c_{12}|$, respectively. Lines 1 and 2 correspond to $\phi = \pi \pm y$; on line 5, $\phi = y$ and on line 6, $\phi = 2\pi - y$. The quantity y is defined in Eq. (23)

The integration with respect to the azimuthal angle inside the braces in (23) gives 2π for the first contribution in the right-hand side and π for the second one. Then we obtain

$$\Phi_a = 4\pi(1 + c_{12}) - 4\pi c_{12} = 4\pi.$$

The same result is valid, of course, in the case $c_{12} > 0$.

4.2. Integration over c_2

To investigate the single azimuthal distributions, we have to perform the integration with respect to c_2 . Because the decay matrix element squared contains the contribution that does not depend on any angles and the contributions that are proportional to c_1 (due to the term (Sq)), to c_2 (due to the term (Sk)), and to $s_1 s_2 \sin \phi$ (due to the term $(Spqk)$), the following integrals have to be evaluated:

$$\int \bar{\Phi}_a dc_2(1, c_1, c_2, s_1 s_2 s_\phi).$$

The values of the corresponding integrals, with c_1 and c_2 as integrands, are opposite in sign in the upper ($c_2 > 0$) and lower ($c_2 < 0$) hemispheres, whereas the integral with the integrand $(s_1 s_2 \sin \phi)$ has opposite signs in the right ($\phi < \pi$) and left ($\phi > \pi$) hemispheres. Thus, we can extract the contribution due to the terms proportional to (Sq) and (Sk) in the matrix element squared by taking the difference of the event number in the upper and lower hemispheres and the term proportional to $(Spqk)$, in the right and left ones. The event number for an unpolarized τ lepton is the same inside all the hemispheres. In what follows, we normalize the different asymmetries and the correlation parameters by the corresponding unpolarized event numbers.

In spite of the nontrivial form of the phase space factor, the integration over the c_2 variable can be performed analytically. The necessary integrals are

$$I_{c_1}(\phi, c_{12}) = \int_0^1 c_1 dc_2 \bar{\Phi}_a, \quad I_{c_2}(\phi, c_{12}) = \int_0^1 c_2 dc_2 \bar{\Phi}_a,$$

$$I(\phi, c_{12}) = \int_{-1}^1 dc_2 \bar{\Phi}_a, \quad I_\phi(\phi, c_{12}) = \int_{-1}^1 s_1 s_2 s_\phi dc_2 \bar{\Phi}_a.$$

When integrating, we have to take the ranges of the variables c_2 and ϕ given in Fig. 4 into account and consider the cases $c_{12} > 0$ and $c_{12} < 0$ separately. Thus, we have

$$s_\phi^3 I_{c_1}(\phi, c_{12} > 0) = (s_\phi - \phi c_\phi)(1 - c_{12}) + 2c_\phi W_1 - 2\sqrt{c_\phi^2 - c_{12}^2} \tan \phi, \quad 0 < \phi < \theta_{12},$$

$$[(\pi - \phi)c_\phi + s_\phi](1 - c_{12}), \quad \theta_{12} < \phi < 2\pi - \theta_{12},$$

$$[s_\phi + (2\pi - \phi)c_\phi](1 - c_{12}) + 2c_\phi W_1 - 2 \tan \phi \sqrt{c_\phi^2 - c_{12}^2}, \quad 2\pi - \theta_{12} < \phi < 2\pi, \quad (24)$$

$$W_1 = \arctan x - c_{12} \arctan(c_{12} x),$$

$$x = \frac{s_\phi}{\sqrt{c_\phi^2 - c_{12}^2}}.$$

In the case $c_{12} < 0$, we have

$$s_\phi^3 I_{c_1}(\phi, c_{12} < 0) = (1 + c_{12})(\phi c_\phi - s_\phi), \quad 0 < \phi < \theta_{12},$$

$$- [s_\phi + (\pi - \phi)c_\phi](1 + c_{12}) + 2c_\phi W_1 - 2 \tan \phi \sqrt{c_\phi^2 - c_{12}^2}, \quad \theta_{12} < \phi < 2\pi - \theta_{12}, \quad (25)$$

$$- [s_\phi + (2\pi - \phi)c_\phi](1 + c_{12}), \quad 2\pi - \theta_{12} < \phi < 2\pi.$$

It is obvious that in the case $c_{12} = 0$, the functions $I_{c_1}(\phi, c_{12} > 0)$ and $I_{c_1}(\phi, c_{12} < 0)$ have to coincide. This can be seen using the relations

$$\arctan(\tan x) = \begin{cases} x, & 0 < x < \frac{\pi}{2}, \\ x - \pi & \frac{\pi}{2} < x < \frac{3\pi}{2}, \\ x - 2\pi, & \frac{3\pi}{2} < x < 2\pi. \end{cases}$$

We write analogous formulas for the quantity $I_{c_2}(\phi, c_{12})$. In the case $c_{12} > 0$,

$$s_\phi^3 I_{c_2}(\phi, c_{12} > 0) = \begin{cases} (s_\phi - \phi c_\phi)(1 - c_{12}) + 2c_\phi W_2, & 0 < \phi < \theta_{12}, \\ [(\pi - \phi)c_\phi + s_\phi](1 - c_{12}), & \theta_{12} < \phi < 2\pi - \theta_{12}, \\ [(2\pi - \phi)c_\phi + s_\phi](1 - c_{12}) + 2c_\phi W_2, & 2\pi - \theta_{12} < \phi < 2\pi, \end{cases} \quad (26)$$

$$W_2 = \arctan(c_{12} x) - c_{12} \arctan x.$$

At negative values of c_{12} , we can write

$$s_\phi^3 I_{c_2}(\phi, c_{12} < 0) = \begin{cases} (s_\phi - \phi c_\phi)(1 + c_{12}), & 0 < \phi < \theta_{12}, \\ [(\pi - \phi)c_\phi + s_\phi](1 + c_{12}) + 2c_\phi W_2, & \theta_{12} < \phi < 2\pi - \theta_{12}, \\ [(2\pi - \phi)c_\phi + s_\phi](1 + c_{12}), & 2\pi - \theta_{12} < \phi < 2\pi. \end{cases} \quad (27)$$

Again, we see that at $c_{12} = 0$, expressions (26) and (27) coincide because in this case $W_2 = 0$.

To investigate the differential right-left effects, it is enough to calculate the quantity $I_\phi(\phi, c_{12})$ for the azimuthal angle $0 < \phi < \pi$. We can write it in terms of the standard elliptic functions

$$I_\phi(\phi, c_{12} > 0) = \frac{2c_{12} c_\phi}{s_\phi^3} \ln(c_\phi^2 + c_{12}^2 s_\phi^2) + \begin{cases} F1(\phi), & 0 < \phi < \theta_{12}, \\ 4s_{12} \tan \theta_{12} \cot \phi \csc^2 \phi - F2(\phi), & \theta_{12} < \phi < \pi - \theta_{12}, \\ F1(\phi), & \pi - \theta_{12} < \phi < \pi. \end{cases} \quad (28)$$

The function $F1(\phi)$ is defined as

$$F1(\phi) = \frac{2s_{12}}{s_\phi} \times \left\{ K(z) + F(v|z) - \frac{2}{s_\phi^2} [E(z) + E(v|z)] \right\} - \frac{4(c_{12}^2 - c_\phi^2)}{s_{12} s_\phi^3} [\Pi(w|z) + \Pi(w; v|z)] + 4c_{12}/s_\phi c_\phi, \quad (29)$$

where

$$z = s_\phi^2/s_{12}^2, \quad v = \arcsin(c_{12} \sec \phi),$$

$$w = \cot^2 \theta_{12} \tan^2 \phi,$$

and K , E , Π , and F are the standard elliptic functions [28]. The function $F2(\phi)$ is

$$F2(\phi) = -\frac{s_{12}^2}{s_\phi^2} [K(z_1) + F(v_1|z_1)] + \frac{4}{s_\phi^2} [E(z_1) + E(v_1|z_1)] + \frac{4(c_\phi^2 - c_{12}^2)}{s_\phi^4} [\Pi(w_1|z_1) + \Pi(w_1; v_1|z_1)], \quad (30)$$

where

$$z_1 = \frac{1}{z}, \quad v_1 = \arcsin \frac{c_\phi}{c_{12}}, \quad w_1 = \frac{1}{w}.$$

We note that in the regions where the $F1$ ($F2$) function makes a contribution to Eq. (28), the condition $z < 1$ ($z_1 < 1$) is always satisfied. As concerns the quantity $I_\phi(\phi, c_{12} < 0)$, its analytical form coincides with (28)

except for the restrictions on the azimuthal angle: in the upper row, we have to write $0 < \phi < \pi - \theta_{12}$, in the middle row, $\pi - \theta_{12} < \phi < \theta_{12}$, and in the bottom one, $\theta_{12} < \phi < \pi$.

As noted before, we normalize the differential with respect to the azimuthal angle ϕ by the corresponding unpolarized quantities. Therefore, we need to also calculate a pure phase space integral $I(\phi, c_{12})$, and we write it in terms of the functions

$$F3(n, l, m) = \frac{2c_{12} c_\phi}{s_\phi^2} [F(l|m) - \Pi(n; l|m)],$$

$$L = -\frac{1}{s_\phi^2} \ln(c_\phi^2 + c_{12}^2 s_\phi^2).$$

If $c_{12} > 0$, we have

$$I(\phi, c_{12} > 0) = L + \begin{cases} [F3(s_\phi^2, \theta_{12}, z) - 2F3(s_\phi^2, \pi/2, z)]/s_{12}, & 0 < \phi < \theta_{12}, \\ [F3(s_{12}, \phi, 1/z) - 2F3(s_{12}, \pi/2, 1/z)]/s_\phi, & \theta_{12} < \phi < \pi - \theta_{12}, \\ -F3(s_\phi^2, \theta_{12}, z)/s_{12}, & \pi - \theta_{12} < \phi < \pi + \theta_{12}, \\ [F3(s_{12}, \phi, 1/z) - 2F3(s_{12}, \pi/2, 1/z)]/s_\phi, & \pi + \theta_{12} < \phi < 2\pi - \theta_{12}, \\ [F3(s_\phi^2, \theta_{12}, z) - 2F3(s_\phi^2, \pi/2, z)]/s_{12}, & 2\pi - \theta_{12} < \phi < 2\pi. \end{cases} \quad (31)$$

If $c_{12} < 0$,

$$I(\phi, c_{12} < 0) = L + \begin{cases} -F3(s_\phi^2, \theta_{12}, z)/s_{12}, & 0 < \phi < \pi - \theta_{12}, \\ -F3(s_{12}, \phi, 1/z)/s_\phi, & \pi - \theta_{12} < \phi < \theta_{12}, \\ [F3(s_\phi^2, \theta_{12}, z) - 2F3(s_\phi^2, \pi/2, z)]/s_{12}, & \theta_{12} < \phi < 2\pi - \theta_{12}, \\ F3(s_{12}, 2\pi - \phi, 1/z)/s_\phi, & 2\pi - \theta_{12} < \phi < \pi + \theta_{12}, \\ -F3(s_\phi^2, \theta_{12}, z)/s_{12}, & \pi + \theta_{12} < \phi < 2\pi. \end{cases} \quad (32)$$

In accordance with Eq. (22), the relation

$$\int_0^{2\pi} I(\phi, c_{12}) d\phi = 4\pi$$

has to take place at any permissible value of c_{12} . We could not show this analytically but verified this relation by numerical integration. In this connection, we note that the quantities $I_{c_1}(\phi, c_{12})$, $I_{c_2}(\phi, c_{12})$ and $I_\phi(\phi, c_{12})$ also satisfy the conditions that can be deduced from a comparison of two different approaches to the angular integration given by Eqs. (6) and (18):

$$\int_0^{2\pi} [I_{c_1}(\phi, c_{12}); I_{c_2}(\phi, c_{12})] d\phi = [\pi c_{12}; \pi],$$

$$\int_0^\pi I_\phi(\phi, c_{12}) d\phi = \pi s_{12}.$$

4.3. Up-down differential asymmetries

In [18], we found that in the rest frame, the angular distribution of the decay width relative to the polar angle of the photon θ_2 is trivial if the integration over the polar angle of the pion is performed: it is proportional to c_2 if the τ lepton is polarized and does not depend on this angle in the unpolarized case.

The situation is different if we are interested in the azimuthal distribution. As we can see from the above results, even the pure phase-space part, defined by Eq. (22), exhibits a nontrivial dependence on the angle θ_{12} (see also the angular region in Fig. 4). This dependence does not disappear after the integration over θ_2 , as can be seen from Eqs. (31) and (32). That is an essential difference from the polar angle distribution. The function $I(\phi, c_{12})$ is plotted in Fig. 2b for fixed positive and negative values of c_{12} .

To demonstrate this effect in detail, in Figs. 5–9, we give the azimuthal distribution of the decay width integrated over the variable c_2 in the upper hemisphere ($0 < \theta_2 < \pi/2$; $0 < \phi < 2\pi$), for both unpolarized and spin-dependent parts (the corresponding quantities are labeled by “up”). The spin-dependent part in these figures includes the contributions proportional to (Sq) and (Sk) and does not include the contribution proportional to $(Spqk)$. The reason is that the last contribution, as well as the spin-independent part, is the same in the upper and lower ($\pi/2 < \theta_2 < \pi$; $0 < \phi < 2\pi$) hemispheres, whereas the first two terms are opposite in sign. This means that we can separate the contribution due to (Sq) and (Sk) by taking the difference between the events in the upper and lower hemispheres (the corresponding quantities are labeled by “ud”). Because of the infrared divergence, we restrict ourselves in what follows by the condition $\omega > 0.3$ GeV, where the IB and resonance contributions are of the same order. At small photon energies, the IB contribution dominates, and it is impossible to use the events in this region for determining the form factors.

In Fig. 5, we show the azimuthal distribution of the decay width corresponding to the spin-independent part only, derived by a numerical integration over the pion and photon energies. We note a very strong sensitivity of this distribution to the parameter sets used to describe the structural resonance amplitude in the wide range around $\phi = \pi$, where the IB contribution has a minimum. We can conclude that the measurements in this region can be very important as regards discriminating between different theoretical models as well as between the parameter values used in these models.

The effects caused by the τ -lepton polarization due to the contribution of the terms containing (Sq) and (Sk) are shown in Fig. 6. Together with the decay width, we here show the polarization asymmetry defined as

$$A^{ud}(\phi) = \frac{d\Gamma_0^{up} + d\Gamma_0^{(s)up} - d\Gamma_0^{dn} - d\Gamma_0^{(s)dn}}{d\Gamma_0^{up} + d\Gamma_0^{(s)up} + d\Gamma_0^{dn} + d\Gamma_0^{(s)dn}} = \frac{d\Gamma_0^{(s)up}}{d\Gamma_0^{up}}, \quad (33)$$

where we let “dn” label the events in the lower hemisphere and use the symmetry relations

$$d\Gamma_0^{up} = d\Gamma_0^{dn}, \quad d\Gamma_0^{(s)up} = -d\Gamma_0^{(s)dn}.$$

Again, we see a strong sensitivity of both the spin-dependent decay width and the polarization asymmetry to the resonance parameter sets in a wide region around $\phi = \pi$.

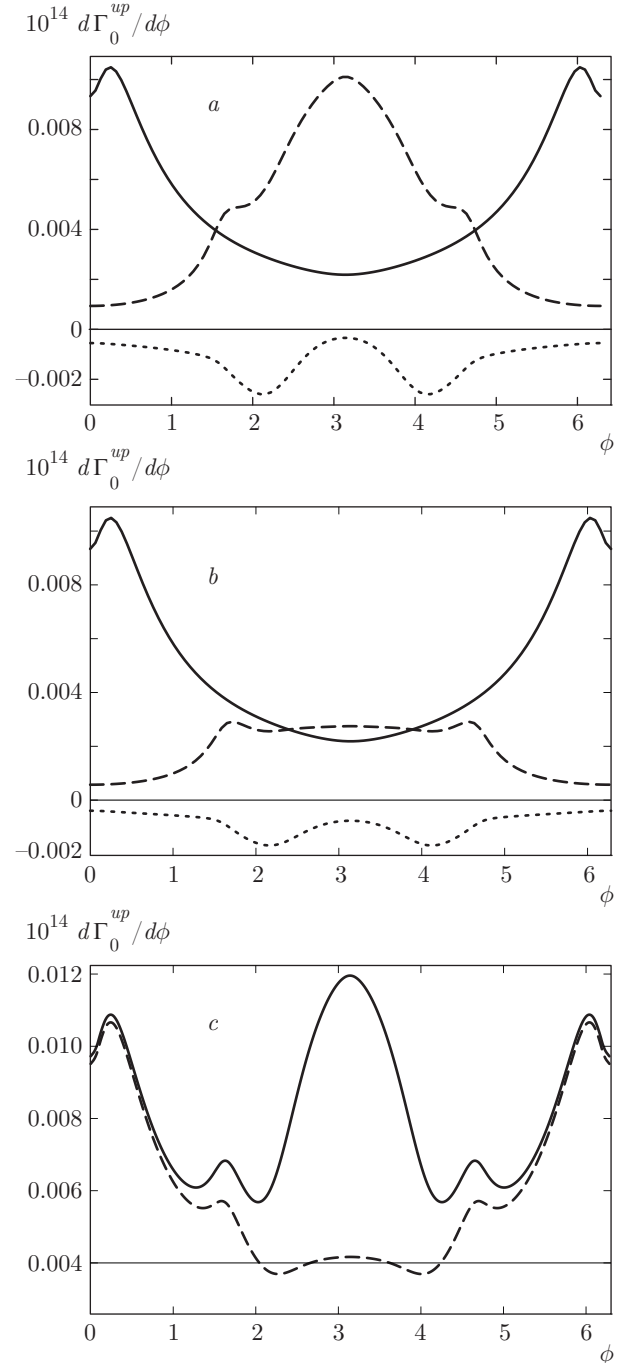

Fig. 5. The spin-independent part of the differential decay width (in $\text{GeV}\cdot\text{rad}^{-1}$), integrated over the variable c_2 in the upper hemisphere, versus the azimuthal angle. Panel *a* shows the IB contribution (the solid line), the resonance contribution (the dashed line), and the IB resonance interference (the dotted line) for set 1 of the resonance parameters given in Table; panel *b* is the same but for set 2; panel *c* shows the sum of all the contributions for set 1 (the solid line) and set 2 (the dashed line)

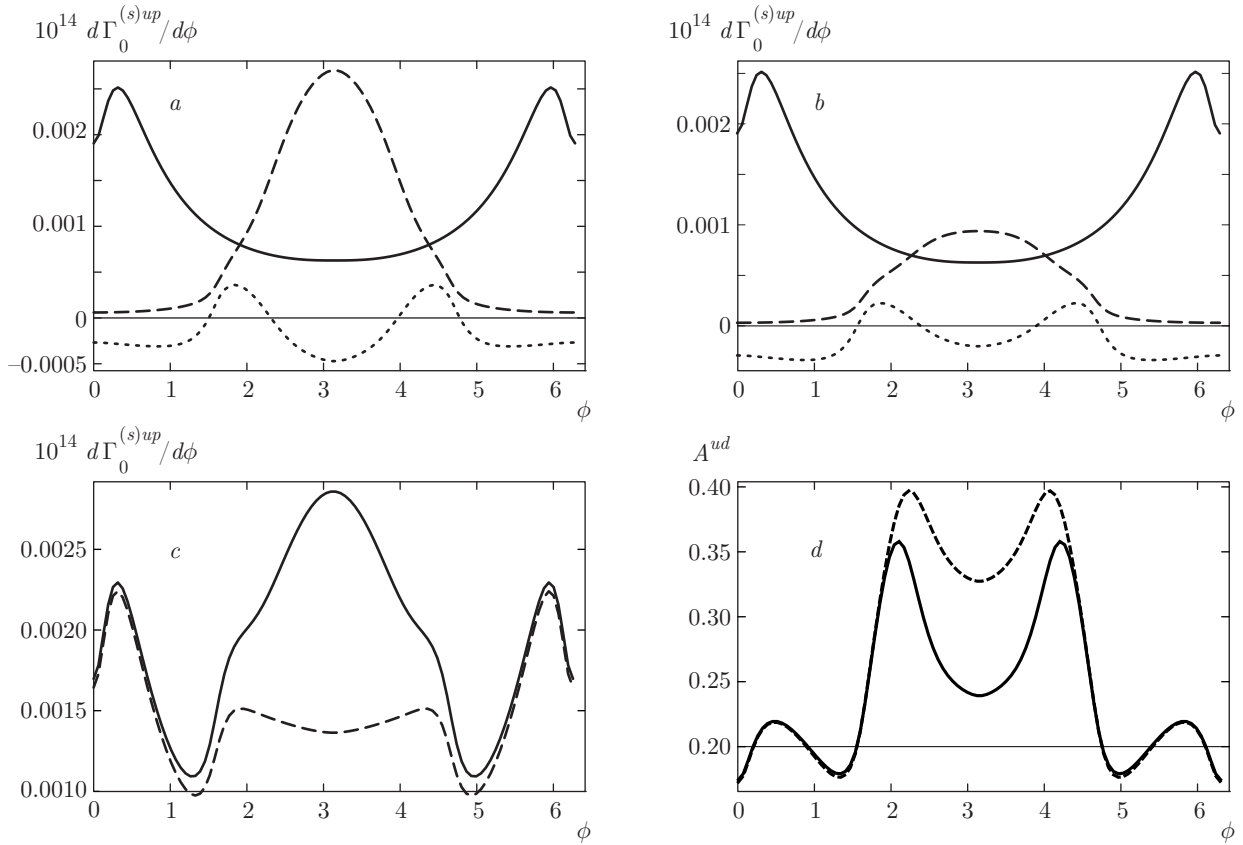

Fig. 6. The quantities caused by the τ -lepton polarization in the case of unpolarized photon. The notation for the quantities $d\Gamma_0^{(s)up}/d\phi$ is the same as in Fig. 5; the polarization asymmetry A^{ud} is calculated in accordance with Eq. (33) for set 1 (the solid line) and set 2 (the dashed line) of the parameters

In Figs. 7, 8, we present the azimuthal distributions for those spin-independent (spin-dependent) contributions to the partial decay width $d\Gamma_i$ that define the photon Stokes parameter ξ_i^{up} (the correlation parameters describing the influence of the τ -lepton polarization on the ξ_i^{ud}), $i = 1, 2, 3$. These partial decay widths are not positive definite. We note that the pure IB contribution disappears for $i = 1$.

We also recall that the parameters ξ_1 and ξ_3 , which describe the linear polarization of the photon, depend on the choice of the photon polarization 4-vectors, but the parameter ξ_2 , describing the circular polarization, does not.

In Fig. 9, we show the double distributions with respect to the angle ϕ and the invariant variable t for the up-down asymmetry and the correlation parameters. The corresponding integrated quantities $A^{ud}(\phi)$ and $\xi_i^{ud}(\phi)$ are shown in Figs. 6 and 8.

4.4. Right-left differential asymmetries

As noted above, the azimuthal distribution caused by the $(Spqk)$ term in the differential decay width can be separated by taking the difference between the events number in the right (R) hemisphere ($0 < \theta_2 < \pi$; $0 < \phi < \pi$) at a fixed value of ϕ and in the left (L) hemisphere ($0 < \theta_2 < \pi$; $\pi < \phi < 2\pi$) at the angle $2\pi - \phi$. We let the corresponding differences be labeled by “ RL ”. We can define the corresponding asymmetry and the correlation parameters as

$$A^{RL}(\phi) = \frac{d\Gamma^R(\phi) - d\Gamma^L(2\pi - \phi)}{d\Gamma_0(\phi) + d\Gamma_0(2\pi - \phi)} = \frac{d\Gamma^R(\phi)}{d\Gamma_0(\phi)}, \quad (34)$$

$$\xi_i^{RL}(\phi) = \frac{d\Gamma_i^R(\phi)}{d\Gamma_0(\phi)},$$

where $d\Gamma_0^{R(L)}(\phi)$ and $d\Gamma_i^R(\phi)$ are determined by the spin-dependent part (the term $(Spqk)$) of $|M_\gamma|^2$, and $d\Gamma_0(\phi)$ is determined by the spin-independent one.

In Figs. 10–12, we show some differential right-left asymmetries.

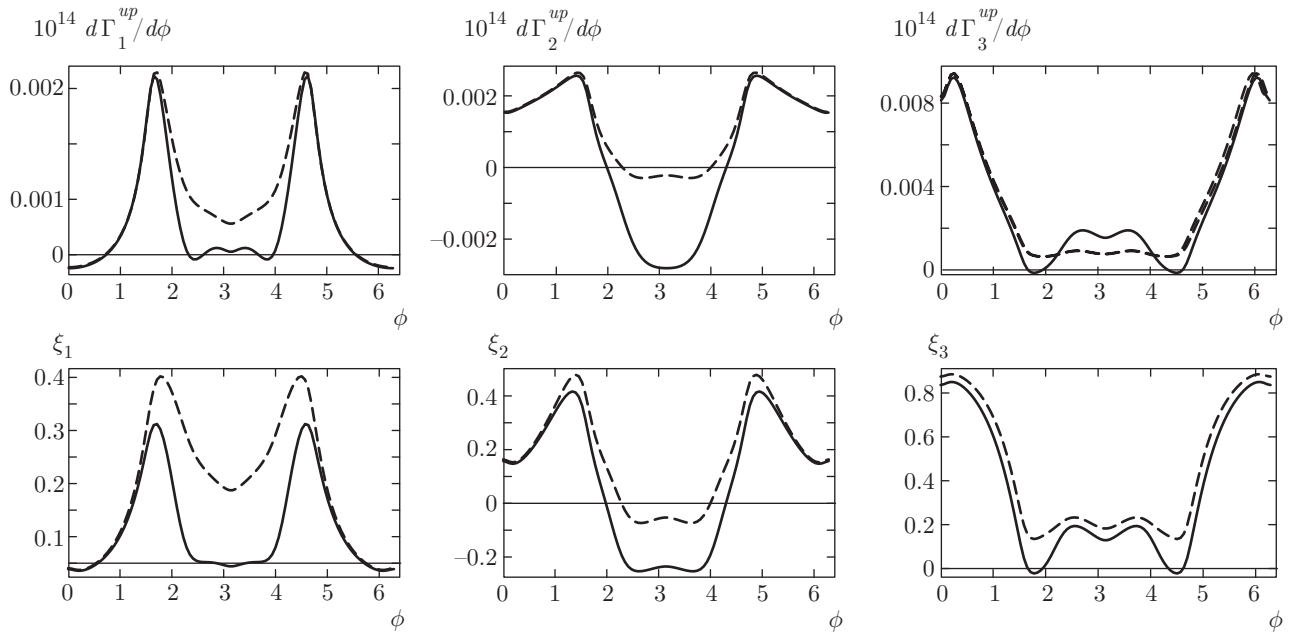

Fig. 7. The partial decay widths (the upper row, in $\text{CeV}\cdot\text{rad}^{-1}$) and the corresponding Stokes parameters (the lower row) are calculated for an unpolarized τ lepton, in accordance with Eq. (5), in the upper hemisphere. The solid line corresponds to set 1 and the dashed line to set 2 of the parameters

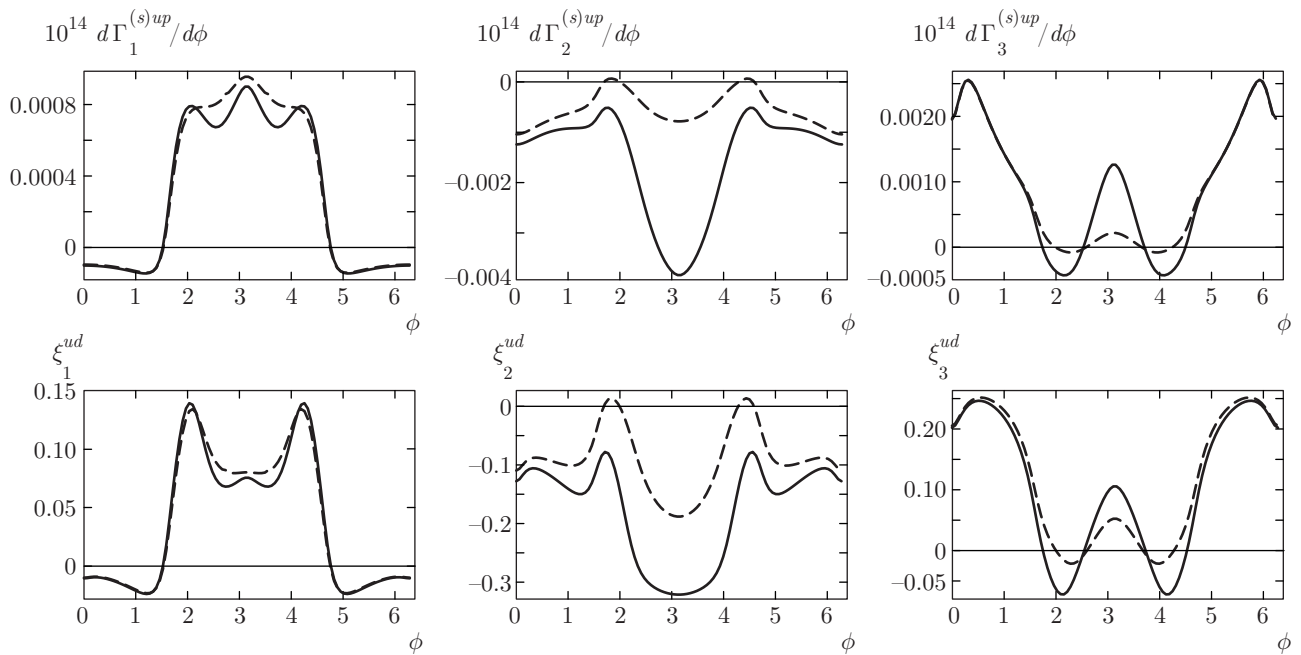

Fig. 8. The same as in Fig. 7 but for a polarized τ lepton and for the difference of the corresponding events in the upper and lower hemispheres

5. DISCUSSION

We have investigated the photon angular distributions in the radiative decay of a polarized τ -lepton.

Special attention is paid to the study of the distribution over the photon azimuthal angle. If τ is unpolarized, the squared matrix element depends on a pair of dynamical variables only (the pion and photon energies,

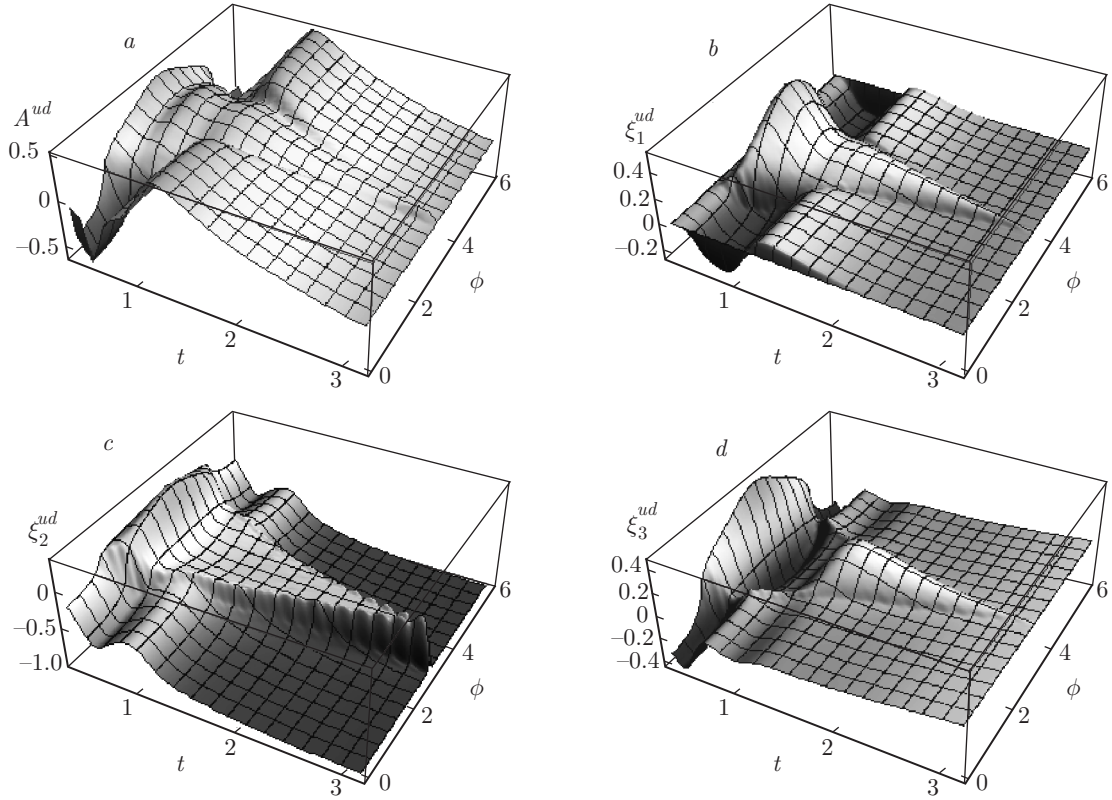

Fig. 9. (a) The double differential distributions for the up–down asymmetry $A^{ud}(t, \phi)$ and (b,c and d) the correlation parameters $\xi_1^{ud}(t, \phi)$, $\xi_2^{ud}(t, \phi)$, and $\xi_3^{ud}(t, \phi)$ calculated with set 2 of the parameters. The t variable is given in GeV^2

for example), and the angular part of the photon phase space in the coordinate system with the movable z axis along the photon 3-momentum is fully factored. In this case, the angular dependence of the decay width is absent. But in the system with a fixed z axis (along an arbitrary direction), the photon angular phase space also depends on the dynamical variables, via the quantity

$$c_{12} = \frac{M^2 + m^2 + 2\omega\epsilon - 2M(\omega + \epsilon)}{2\omega|\mathbf{q}|}$$

(see Eqs. (6) and (18)). If we use the angular δ -function to perform the azimuthal integration, then only the double angular distribution is nontrivial, because the integration with respect to any polar angle leads to the factorization of the residual part. This approach also allows studying some effects arising due to the τ -lepton polarization (the terms containing (Sq) and (Sk) in $|M_\gamma|^2$). The corresponding double and single angular distributions can be calculated using Eqs. (7) and (9). Choosing the z axis along the direction of the polarization vector, in the τ rest frame (see Fig. 2), we used this formalism in Ref. [18] to investigate the integral up–down effects with a polarized τ lepton.

Using a similar approach, we can carry out the azimuthal integration in the right and left hemispheres separately, and study the difference of the corresponding quantities caused by the spin-dependent terms proportional to $(Spqk)$. We obtain analytic expressions for the t -distribution of the integral (relative to the azimuthal angle) right–left asymmetries. In Fig. 3, we show the corresponding differential decay width (Eq. (12)) as well as the polarization asymmetry and the polarization parameters defined by Eq. (17). We can see from Fig. 3 that the effects considered have appreciable sensitivity to the parameters used for the description of the resonance amplitude, namely, to the vector and axial-vector form factors. For the differential decay width and the polarization parameters $\xi_1^{RL}(t)$ and $\xi_3^{RL}(t)$, such a sensitivity manifests itself in the region $t \geq 0.6 \text{ GeV}^2$, whereas the polarization asymmetry $A^{RL}(t)$ and the parameter $\xi_2^{RL}(t)$ are considerably different for sets 1 and 2 of the parameters at $t \geq 1 \text{ GeV}^2$. At such values of t , the resonance amplitude M_R can dominate. This means that the integral (with respect to the azimuthal angle) right–left asymmetries can be used to study the model-dependent pa-

rameters used for the description of M_R , in particular, the vector and axial-vector form factors.

We can also keep the azimuthal dependence of the observables and use the δ -function to perform the integration over the pion polar angle. In this case, the residual phase-space factor is more complicated. The ranges of the photon polar (θ_2) and azimuthal (ϕ) angles are defined by Eqs. (20) and (21) and are shown in Fig. 4. They depend essentially on the absolute value and sign of c_{12} and on the solution for c_1 in relation (18). The subsequent integration over c_2 is performed analytically for both spin-dependent and spin-independent contributions in $|M_\gamma|^2$. A somewhat unexpected result is that even the azimuthal dependence of the unpolarized contribution has a nontrivial structure, which is connected directly with the quantity $I(\phi, c_{12})$ defined by Eqs. (31) and (32) and is shown in Fig. 2b for the positive and negative values of c_{12} . The positions of the sharp maxima of the function $I(\phi, c_{12})$, which depend on c_{12} , point to the enhancement of the event number at the corresponding values of the angle ϕ . Because the IB and resonance amplitudes in M_γ depend very differently on the pion and photon energies (and also on c_{12}), we think that the azimuthal distribution of the decay width and of the different polarization observables can be useful in probing the model-dependent resonance contribution. This statement is confirmed by the illustration of the differential up-down (Figs. 5–9) and right-left (Figs. 10–12) asymmetries in decay (1). The curves in these figures are obtained by integrating with respect to the pion and photon energies taking the events with $\omega > 0.3$ GeV into account. This restriction eliminates the events with small photon energies, where the IB mechanism dominates due to the infrared divergence, and it allows studying the resonance mechanism more reliably.

In Figs. 5, 6, we present the spin-independent (the spin-dependent) part of the decay width and the corresponding polarization asymmetry for the events in the upper hemisphere ($c_2 > 0$). First, we note the high sensitivity of these observables to the model parameters, which manifests itself in a strong distinction between the curves in Fig. 5c and in Fig. 6 (the lower row), corresponding to set 1 and set 2 of the parameters. Besides, we note the suppression of the IB contribution and the enhancement of the resonance one for set 1 of the parameters in a wide region around $\phi = \pi$. These remarks remain valid also for the Stokes (Fig. 7) and correlation (Fig. 8) parameters, although we do not separately give the contributions of the corresponding amplitudes and their interference (as in Figs. 5 and 6). The Stokes parameters ξ_1 and ξ_2 as well as the correlation parameter

ξ_2^{ud} show a high model dependence.

In Fig. 9, we demonstrate the double distribution over the t and ϕ variables for the polarization asymmetry and the correlation parameters. The integration over the azimuthal angle in the numerators and denominators of the expressions that define these quantities (see Eq. (5)) allows calculating the t -dependences of these observables obtained in Ref. [18] in an analytic form. We verify the statement by numerical integration over the ϕ variable. We recall that the up-down effects are determined by the difference of the events with the photon in the upper and lower hemispheres, and they are symmetric under the change $\phi \rightarrow 2\pi - \phi$. These effects arise due to the terms proportional to (Sq) and (Sk) in $|M_\gamma|^2$.

The right-left effects, caused by the difference of the events in the right and left hemispheres, are antisymmetric under this change and arise due to the terms proportional to $(Spqk)$. Some of them are presented in Figs. 10–12. We can see that they are several times smaller in absolute value compared with the up-down effects. The quantities ξ_1^{RL} and ξ_3^{RL} , which describe linear polarization of the photons, show a strong dependence on the model-dependent parameters, whereas the parameter of the circular polarization ξ_2^{RL} and the polarization asymmetry A^{RL} do not show such a dependence. Again, by integrating over the ϕ variable the double distributions (over the t and ϕ variables), we can calculate the curves given in Fig. 3 that correspond to our analytic results for the integral left-right effects (Eqs. (7)–(10)). We verified this statement by numerical integration.

In this paper, we mainly analyze the observables with large photon energies ($\omega > 0.3$ GeV) when the values of the IB and resonance amplitudes are of the same order. The measurements in this region allows studying the model-dependent vector and axial-vector form factors. In the region of small photon energies (up to 0.1 GeV), the IB contribution dominates, and the uncertainty of different differential decay widths caused by the form factors is a few percent. Hence, measurements of the A^{ud} or A^{RL} asymmetries in this region can be used, in principle, to determine the τ -lepton polarization degree.

6. CONCLUSION

The radiative one-meson decay of the polarized τ lepton, $\tau^- \rightarrow \pi^- \gamma \nu_\tau$, has been investigated. The presence of the arbitrarily oriented 3-vector of the τ -lepton polarization leads to the azimuthal dependence of the

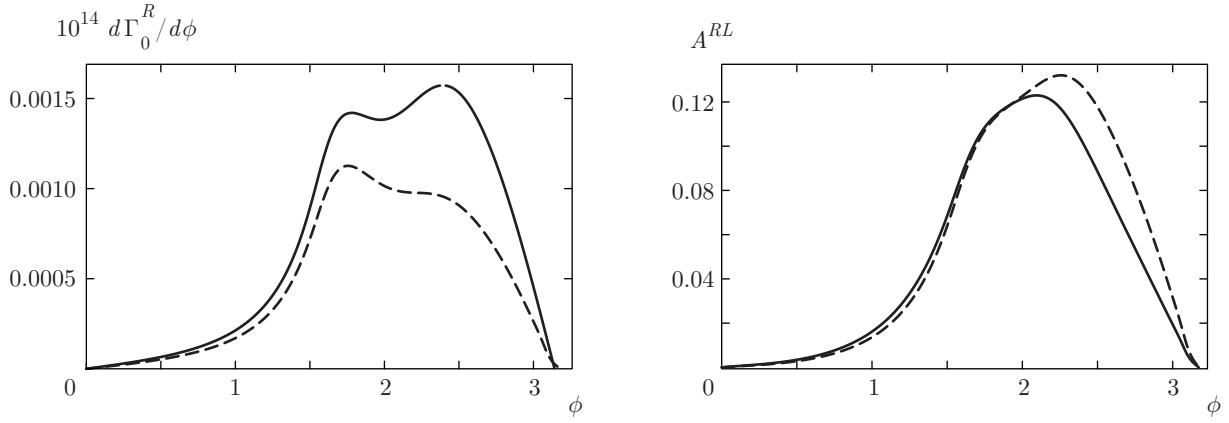

Fig. 10. The decay width (in $\text{GeV}\cdot\text{rad}^{-1}$) due to the terms proportional to $(Spqk)$ in the right hemisphere and the right-left asymmetry defined by Eq. (33). The solid and dashed lines correspond to respective parameter sets 1 and 2

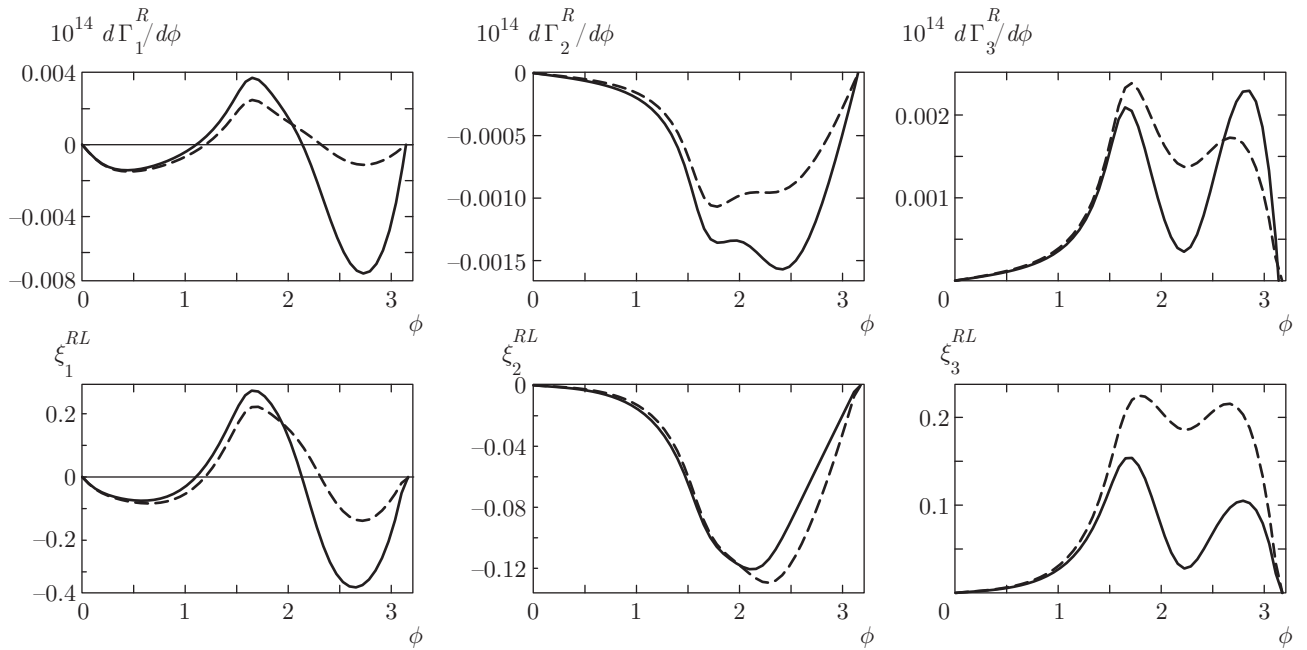

Fig. 11. The partial decay width (in $\text{GeV}\cdot\text{rad}^{-1}$) due to the terms proportional to $(Spqk)$ in the right hemisphere and the right-left asymmetry defined by Eq. (33). The solid and dashed lines correspond to respective parameter sets 1 and 2

emitted photon, which is absent if the τ lepton is unpolarized. We therefore pay special attention to the investigation of the various distributions over the photon azimuthal angle. In connection with this, the photon phase space is discussed in more detail because it is nontrivial in the case of a polarized τ lepton and therefore requires a thorough investigation, and, as we know, such an analysis is absent in the literature. We think that this detailed investigation of the angular part of the three-body phase space can be useful for the analysis of various angular distributions in the three-body

decay of polarized particles. The azimuthal dependence of the following polarization observables has been calculated: the asymmetry caused by the τ -lepton polarization, the Stokes parameters of the emitted photon, and the spin correlation coefficients that describe the influence of the τ -lepton polarization on the photon Stokes parameters.

The amplitude of the τ -lepton decay $\tau^- \rightarrow \pi^- \gamma \nu_\tau$ has two contributions: the inner bremsstrahlung, which does not contain any free parameters, and the structure-dependent term that is parameterized in

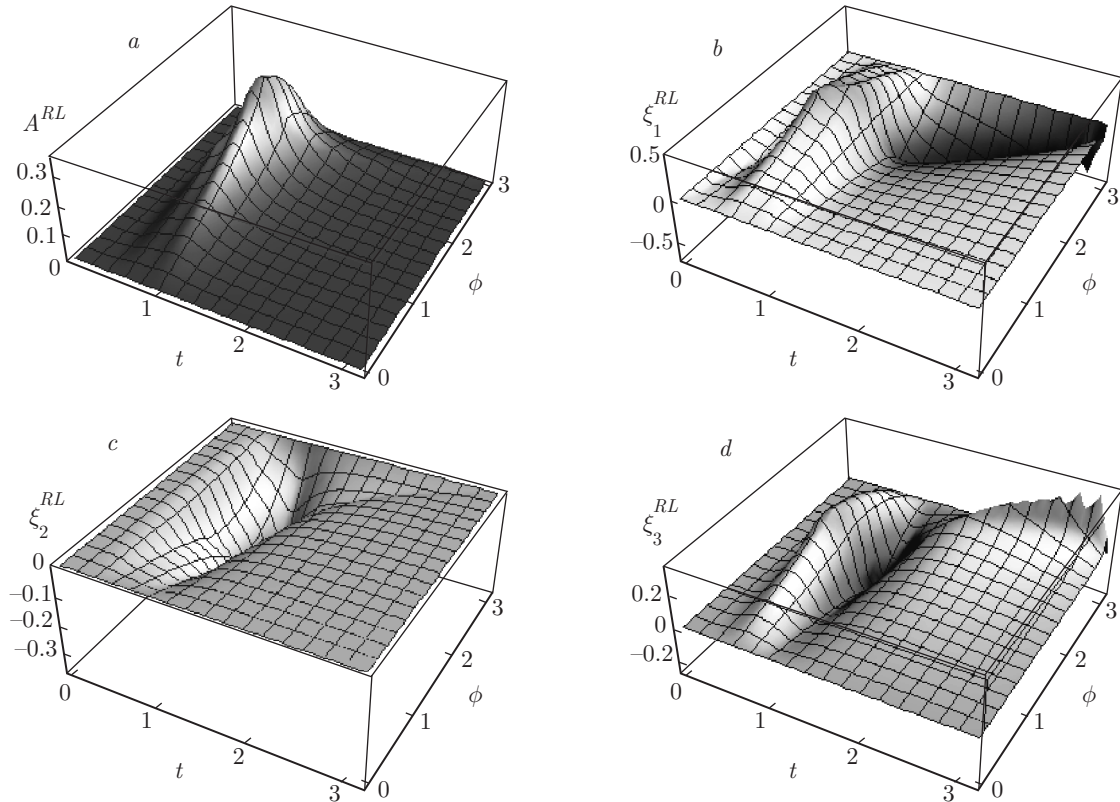

Fig. 12. The same as in Fig. 9 but for the right–left asymmetry and the corresponding correlation parameters, calculated with set 1 of the parameters

terms of the vector and axial-vector form factors. We note that in our case, these form factors are functions of the t variable and $t > 0$, i. e., we are in the time-like region. The form factors are complex functions in this region and their full determination (including not only of their moduli but also their phases) is nontrivial in this case. To do this, it is necessary to perform polarization measurements.

The various observables were calculated for two sets of the parameters describing the vector and axial-vector form factors. A numerical estimation shows that some polarization observables can be effectively used for discriminating between two parameter sets, because these observables significantly differ in some regions of the photon azimuthal angle.

We found that the investigation of the azimuthal distributions of the different observables in the radiative decay of the polarized τ lepton including the decay width, the polarization asymmetry, the Stokes and the correlation parameters of the photon itself is very fruitful for the analysis of the phenomenological models describing the hadronization of weak charged currents.

This work was partially supported by the Ministry of Education and Science of Ukraine (project No. 0115U000474).

REFERENCES

1. N. H. Brook (on behalf of the ZEUS Collaboration), hep-ex/0007023. Talk given at DIS 2000.
2. M. D. Baker (for the Fermilab E 665 Collaboration), arXiv:1312.4914 [nucl-ex].
3. C. Schill (for the COMPASS Collaboration), arXiv:1107.0219 [hep-ex]. Proceedings of DIS 2011, Newport News, USA.
4. S. Falciano et al. (NA10 Collaboration), Z. Phys. C **31**, 513 (1986).
5. M. Guanziroli et al. (NA10 Collaboration), Z. Phys. C **37**, 545 (1988).
6. I. Garzia (for the BaBar Collaboration), arXiv: 1201.4678 [hep-ex].

7. K. Ackerstaff et. al., Nucl. Instrum. Meth. A **417**, 230 (1998), hep-ex/9806008.
8. The CMS Collaboration, Phys. Lett. B **718**, 752 (2013), arXiv:1207.3973 [hep-ex].
9. V. Barone, A. Drago, and P. G. Ratcliffe, Phys. Rep. **359**, 1 (2002) [arXiv:hep-ph/0104283].
10. J. She, Y. Mao, and B.-Q. Ma, Phys. Lett. B **666**, 355 (2008).
11. T. Liu and B.-Q. Ma, arXiv:1201.2472 [hep-ph].
12. J.-H. Gao, A. Schäfer, and J. Zhou, arXiv:1111.1633 [hep-ph].
13. A. Gallegos, J. L. Lucio, G. Moreno, and M. Napsuciale, Phys. Lett. B **693**, 467 (2010).
14. M. Zobov, Part. Nucl. **42**, 1480 (2011).
15. E. Levichev, Part. Nucl. Lett. **5**, 554 (2008).
16. K. Oide, Progr. Theor. Phys. **122**, 69 (2009).
17. A. Pich, Progr. Part. Nucl. Phys. **75**, 41 (2014); arXiv:hep-ph/1310.7922.
18. G. I. Gakh, M. I. Konchatnij, A. Yu. Korchin, and N. P. Merenkov, Zh. Eksp. Teor. Fiz. **147**, 258 (2015); arXiv:hep-ph/1409.6460.
19. J. H. Kim and L. Resnick, Phys. Rev. D **21**, 1330 (1980).
20. S. Banerjee, Phys. Rev. D **34**, 2080 (1986).
21. R. Decker and M. Finkemeier, Phys. Rev. D **48**, 4203 (1993).
22. N. K. Pak, M. P. Rekaló, and T. Yilmaz, Ann. Phys. **241**, 447 (1995).
23. C. Q. Geng and C. C. Lih, Phys. Rev. D **68**, 093001 (2003).
24. Zhi-Hui Guo and P. Roig, Phys. Rev. D **82**, 113016 (2010).
25. P. Roig, A. Guevara, and G. L. Castro, Phys. Rev. D **88**, 033007 (2013); P. Roig, arXiv:1401.4219 [hep-ph].
26. S. Dubinsky, A. Korchin, N. Merenkov, G. Pancheri, and O. Shekhovtsova, Eur. Phys. J. C **40**, 41 (2005); S. Eidelman, S. Ivashyn, A. Korchin, G. Pancheri, and O. Shekhovtsova, Eur. Phys. J. C **69**, 103 (2010); S. A. Ivashin and A. Yu. Korchin, Eur. Phys. J. C **54**, 89 (2008); H. Czyż, S. Ivashin, A. Korchin, and O. Shekhovtsova, Phys. Rev. D **85**, 094010 (2012); K. Kampf and J. Novotny, Phys. Rev. D **84**, 014036 (2011); P. Roig, A. Guevara, and G. L. Castro, Phys. Rev. D **89**, 073016 (2013); I. M. Nugent, T. Predzinski, P. Roig, O. Shekhovtsova, and Z. Was, Phys. Rev. D **88**, 093012 (2013).
27. J. Portolés, AIP Conf. Proc. **1322**, 178 (2014).
28. I. S. Gradshteyn and I. M. Ryzhik, *Tables of Integrals, Sums, Serieses, and Products*, Fizmatgiz, Moscow (1963), in Russian.